

INPUT SHAFT

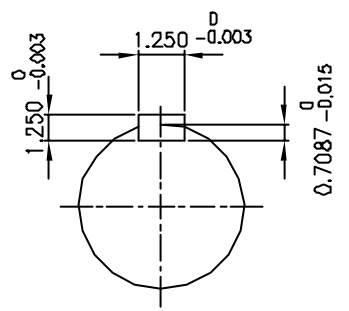

OUTPUT SHAFT

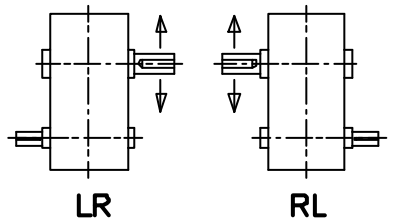

SHAFT ARRANGEMENT & DIRECTION of ROTATION

REV	DESCRIPTION	APPR	CHCK	DRWN	DATE
△					
△					
△					
△					
△					

TYPE SHC 26 (i = 28 ~ 63)				DWG. NAME DIMENSION			
APPROV	CHECK	DESIGN	DRAWN	THIRD ANGLE PROJECTION	SCALE 14/100	DATE 1998.11.27.	
L.H.Y	M.B.U.K.Y.S			REF DWG NO.			
HYOSUNG INDUSTRIES CO.,LTD.				DWG NO.	S K E N 5 6 5 H 5 0		