

INPUT SHAFT

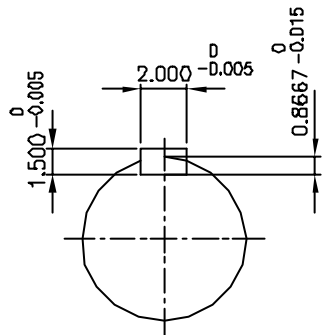

OUTPUT SHAFT

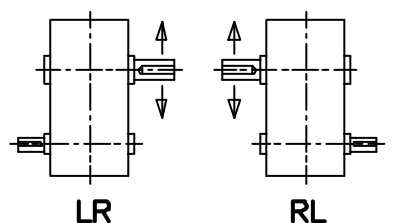

SHAFT ARRANGEMENT & DIRECTION of ROTATION

REV	DESCRIPTION	APPR	CHCK	DRWN	DATE
△					
△					
△					
△					
△					

TYPE SHD 50 (i = 315 ~ 500)				DWG. NAME DIMENSION		
APPROV	CHECK	DESIGN	DRAWN	THIRD ANGLE PROJECTION	SCALE 1/13	DATE 1998.11.26.
L.H.Y	M.B.U	K.Y.S		REF DWG NO.		
HYOSUNG INDUSTRIES CO.,LTD.				DWG NO.	S K E N 5 9 4 H 5 0	