

INPUT SHAFT

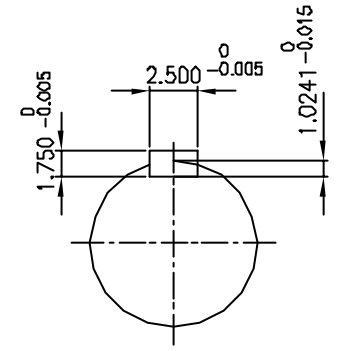

OUTPUT SHAFT

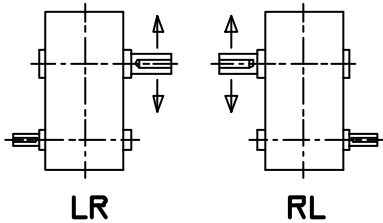

SHAFT ARRANGEMENT & DIRECTION of ROTATION

REV	DESCRIPTION	APPR	CHK	DRWN	DATE
△					
△					
△					
△					
△					

TYPE SHD 61 (i = 112 ~ 280)				DWG. NAME DIMENSION	
APPROV	CHECK	DESIGN	DRAWN	THIRD ANGLE PROJECTION	SCALE 1/16 DATE 1998.11.26.
L.H.Y	M.B.U	K.Y.S		REF DWG NO.	
HYOSUNG INDUSTRIES CO.,LTD.				DWG NO.	S K E N 5 9 7 H 5 0