

INPUT SHAFT

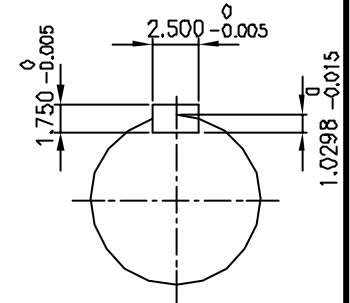

OUTPUT SHAFT

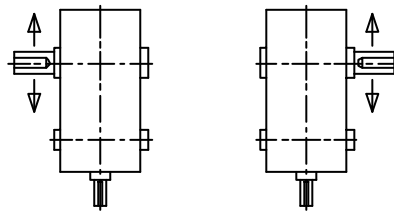

CL CR
**SHAFT ARRANGEMENT &
DIRECTION of ROTATION**

REV	DESCRIPTION	APPR	CHCK	DRWN	DATE
△					
△					
△					
△					
△					

TYPE SKC61 (i = 20 ~ 40)				DWG. NAME DIMENSION			
APPROV	CHECK	DESIGN	DRAWN	THIRD ANGLE PROJECTION	SCALE	1 / 17	DATE 1998.11.26
L.H.Y	M.B.U	K.S.C		REF DWG NO.			
HYOSUNG CORPORATION				DWG NO.	S K E N 6 3 7 HSO		