

INPUT SHAFT

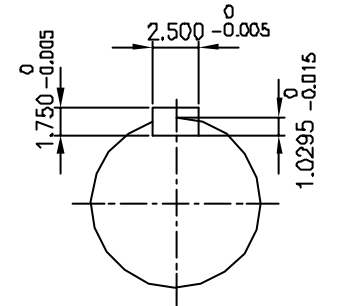

OUTPUT SHAFT

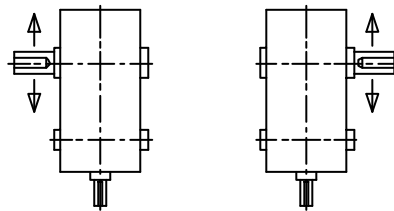

CL CR
SHAFT ARRANGEMENT & DIRECTION of ROTATION

REV	DESCRIPTION	APPR	CHCK	DRWN	DATE
△					
△					
△					
△					
△					

TYPE				DWG. NAME			
SKC61 (i = 45~ 80)				DIMENSION			
APPROV	CHECK	DESIGN	DRAWN	THIRD ANGLE PROJECTION	SCALE	1 / 17	DATE 1998.11.26
L.H.Y	M.B.U	K.S.C		REF DWG NO.			
HYOSUNG CORPORATION				DWG NO.	S K E N 6 3 8 HSO		