

INPUT SHAFT

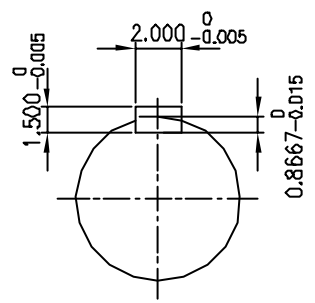

OUTPUT SHAFT

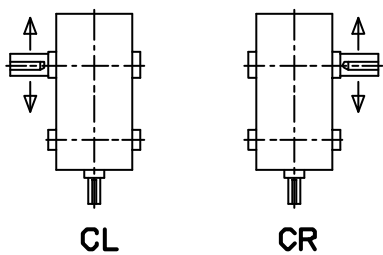

SHAFT ARRANGEMENT & DIRECTION of ROTATION

REV	DESCRIPTION	APPR	CHCK	DRWN	DATE
△					
△					
△					
△					
△					

TYPE				DWG. NAME			
SKD50 (i = 90~ 200)				DIMENSION			
APPROV	CHECK	DESIGN	DRAWN	THIRD ANGLE PROJECTION	SCALE	1/15	DATE 1998.11.26
L.H.Y	M.B.U	J.S.S		REF DWG NO.			
HYOSUNG INDUSTRIES CO.,LTD.				DWG NO.	SKEN653		